

Zeichenerklärung:

	Urgelände		Gradiente Nebentrasse links
	Gradiente		Gradiente Nebentrasse rechts
	Damm		Einschnitt
	Graben / Mulde links		Rohrleitung links
	Graben / Mulde rechts		Rohrleitung rechts

Bauwerk Nr. 13
 Brücke im Zuge der Umgehungsstraße über die Staatsstraße ST 2335
 Bau-km 1+158.45
 LH ≥ 4.70 m
 LW = 17.85 m
 N Br. = 8.00 m
 Br.Kl. = DIN-Fachbericht 101

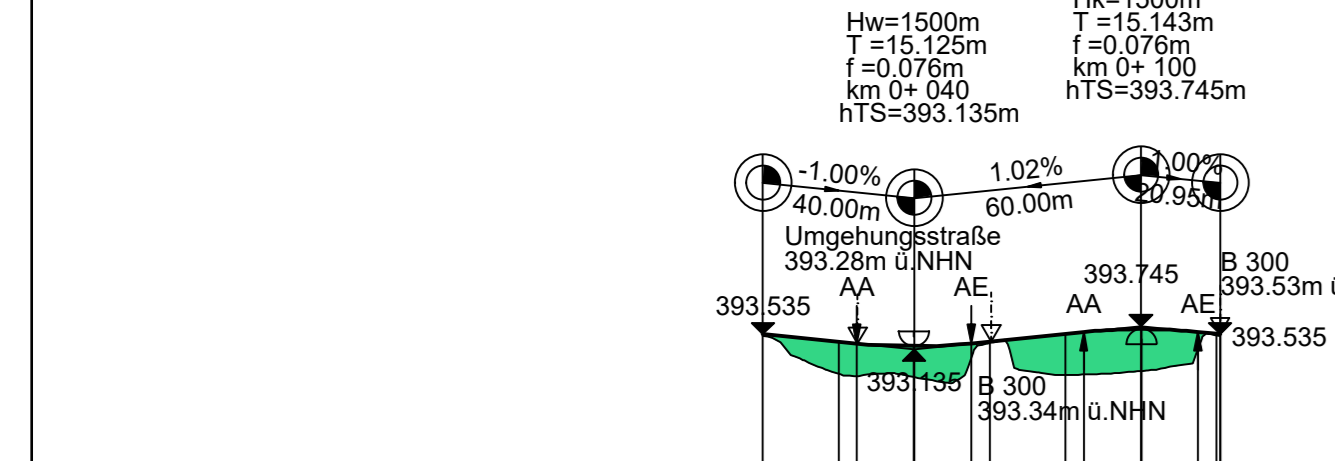

Kreisfahrbahn

Station	m
393.535	393.535
393.198	393.198
393.344	393.344
393.300	393.300
393.535	393.535

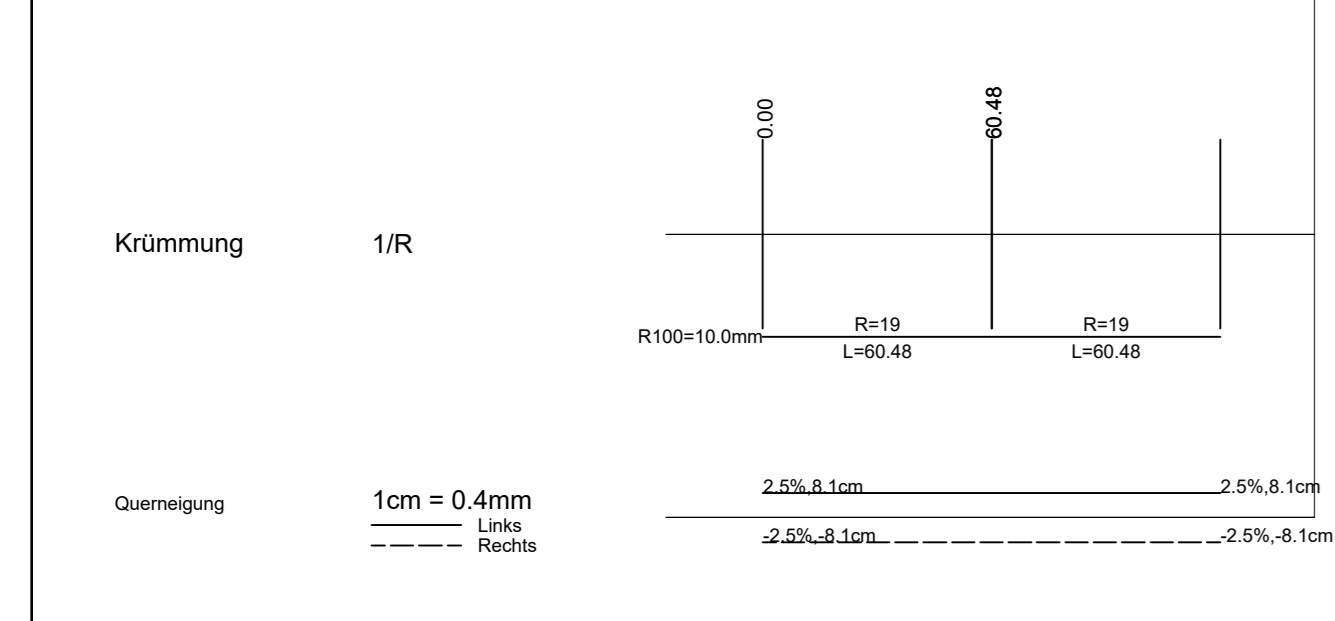

B 300

Station	m
393.121	393.121
392.962	392.962
393.262	393.262
393.454	393.454
393.567	393.567
393.123	393.123

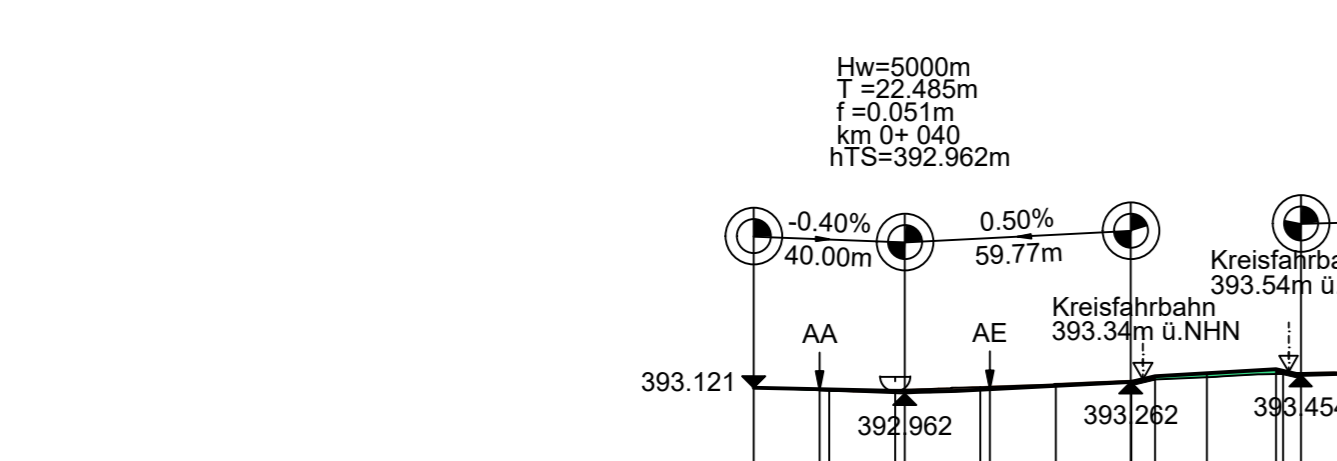

ST 2335

Station	m
373.270	373.270
373.444	373.444
374.15	374.15
374.657	374.657

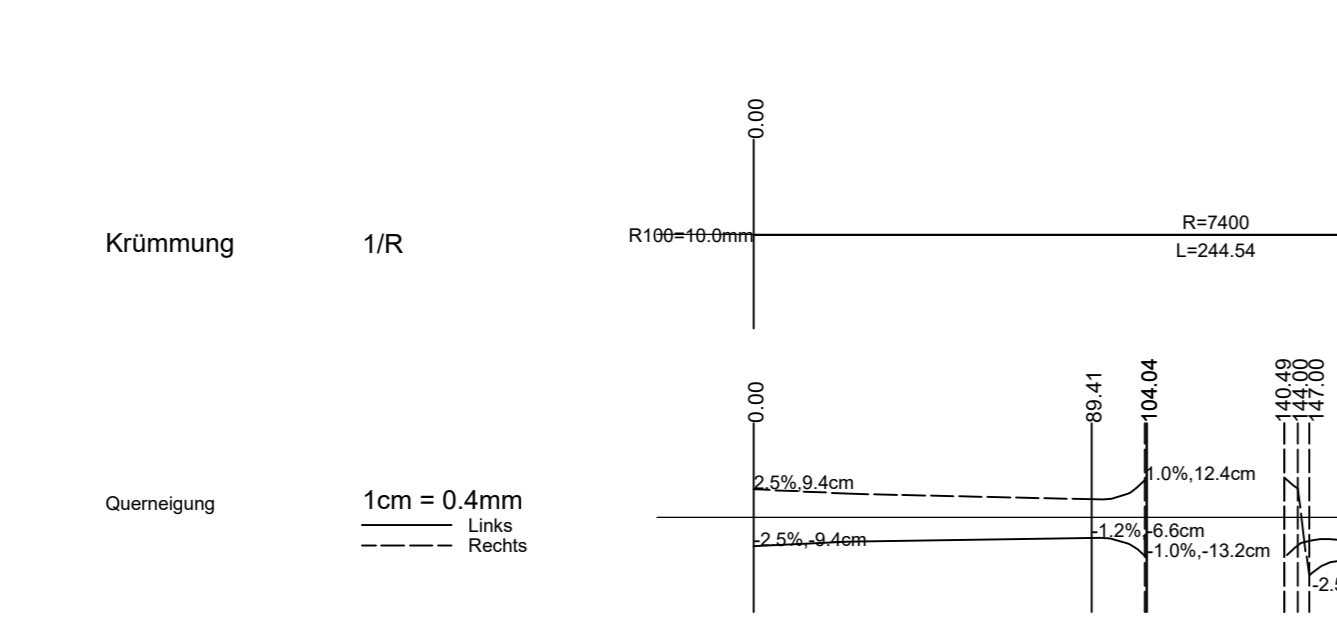

Rampe 1

Station	m
374.284	374.284
374.432	374.432
379.928	379.928
380.573	380.573
380.71	380.71



Rampe 2

Station	m
368.53	368.53
367.81	367.81
370.13	370.13
367.43	367.43

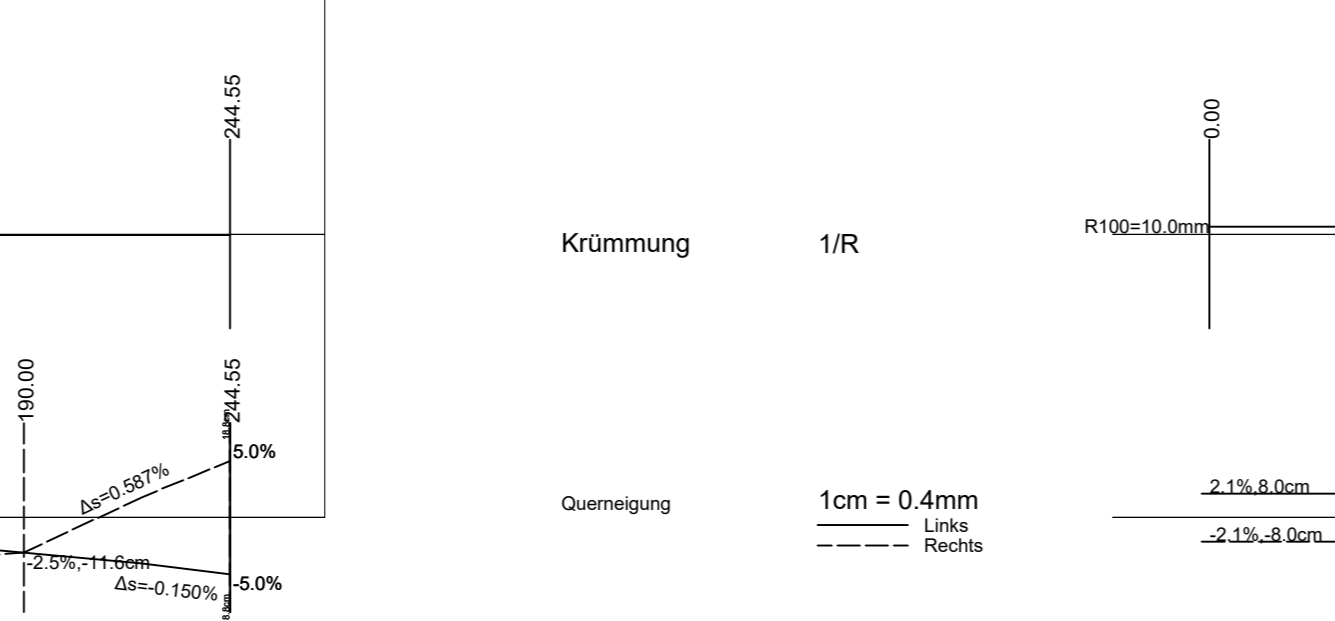

Kreisfahrbahn

Station	m
393.535	393.535
393.198	393.198
393.344	393.344
393.300	393.300
393.535	393.535

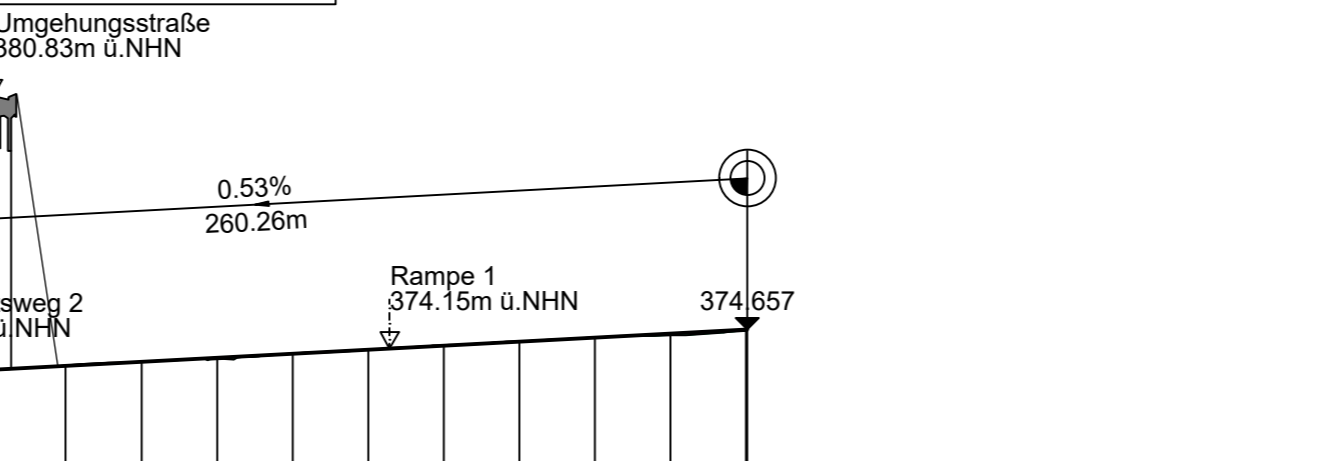

B 300

Station	m
393.121	393.121
392.962	392.962
393.262	393.262
393.454	393.454
393.567	393.567
393.123	393.123

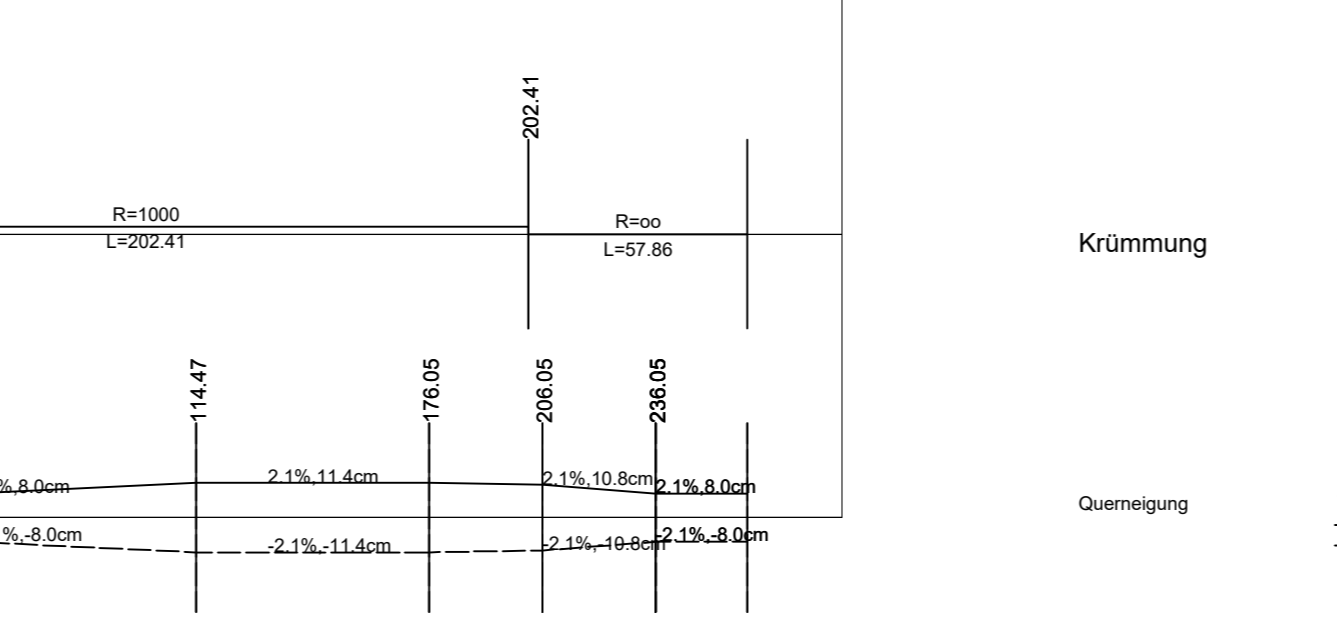

ST 2335

Station	m
373.270	373.270
373.444	373.444
374.15	374.15
374.657	374.657

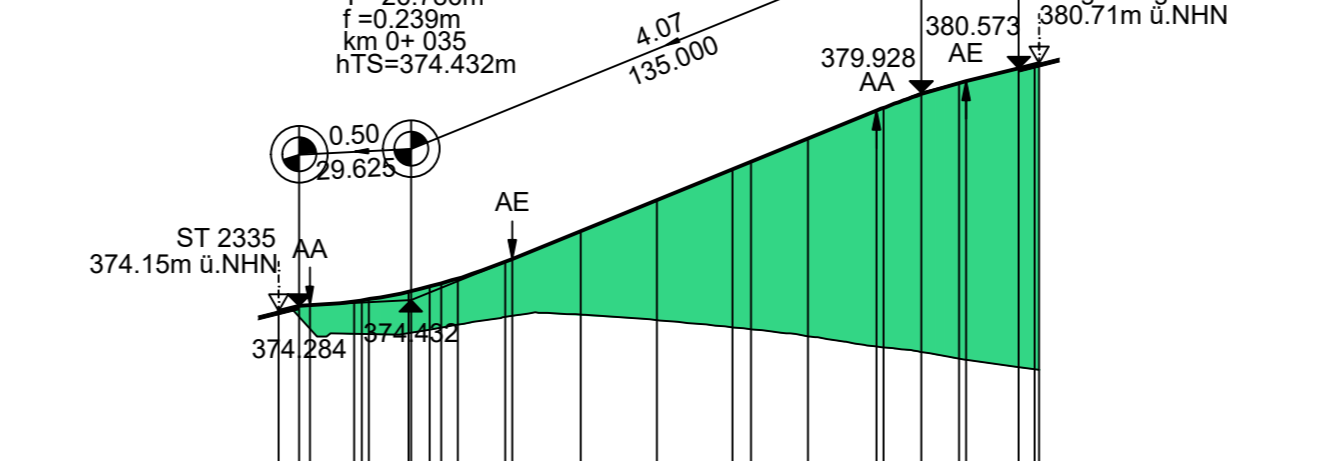

Rampe 1

Station	m
374.284	374.284
374.432	374.432
379.928	379.928
380.573	380.573
380.71	380.71

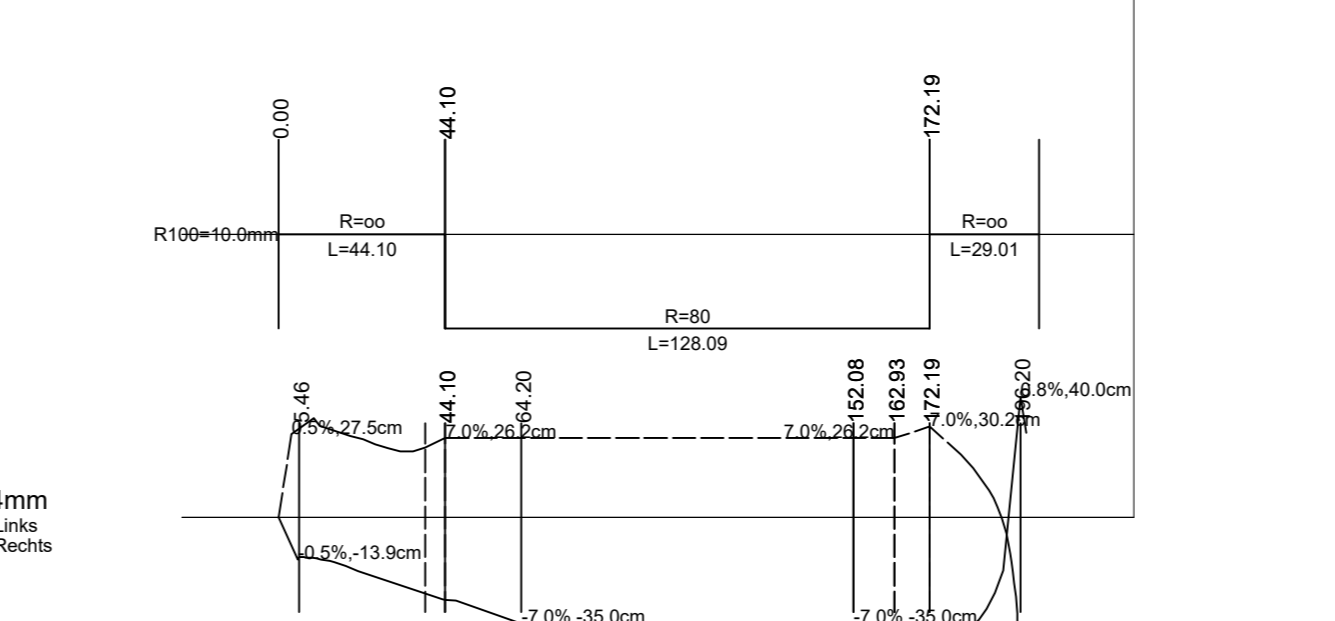

Rampe 2

Station	m
368.53	368.53
367.81	367.81
370.13	370.13
367.43	367.43

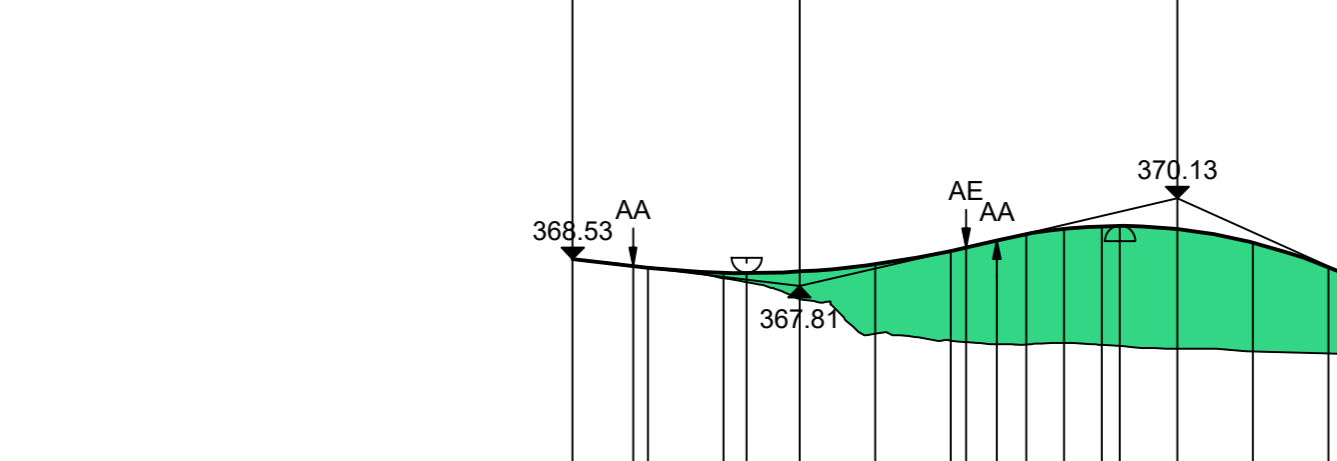

Kreisfahrbahn

Station	m
393.535	393.535
393.198	393.198
393.344	393.344
393.300	393.300
393.535	393.535

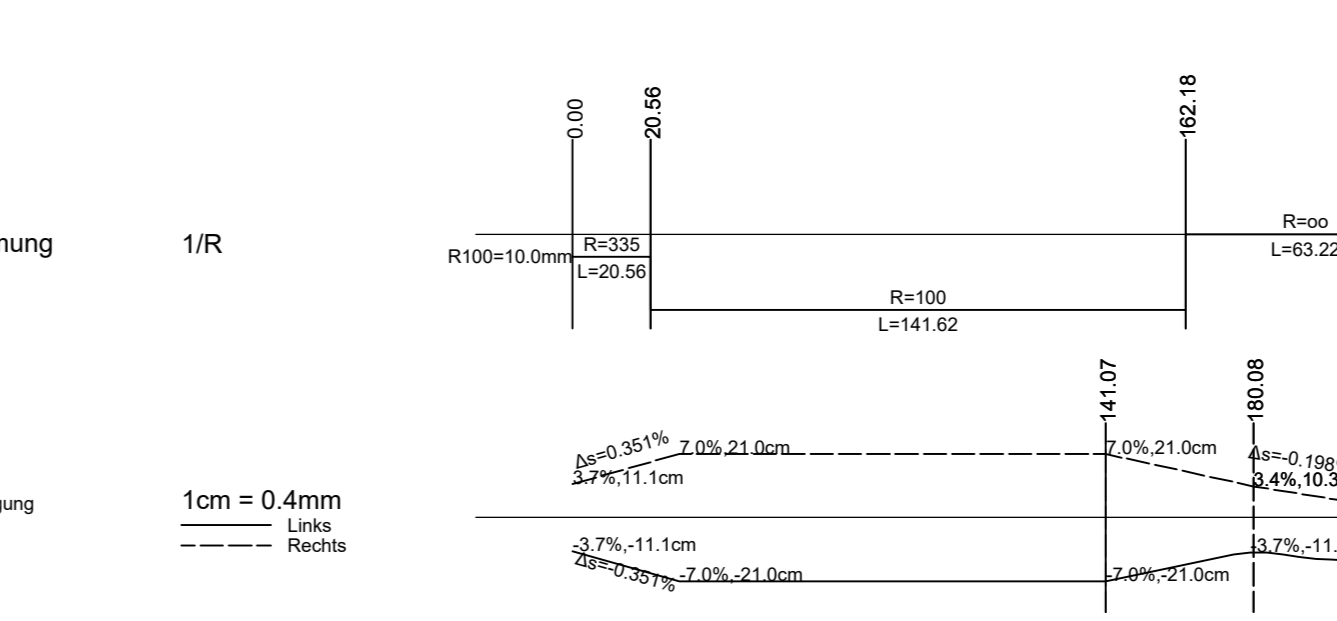

B 300

Station	m
393.121	393.121
392.962	392.962
393.262	393.262
393.454	393.454
393.567	393.567
393.123	393.123



ST 2335

Station	m
373.270	373.270
373.444	373.444
374.15	374.15
374.657	374.657

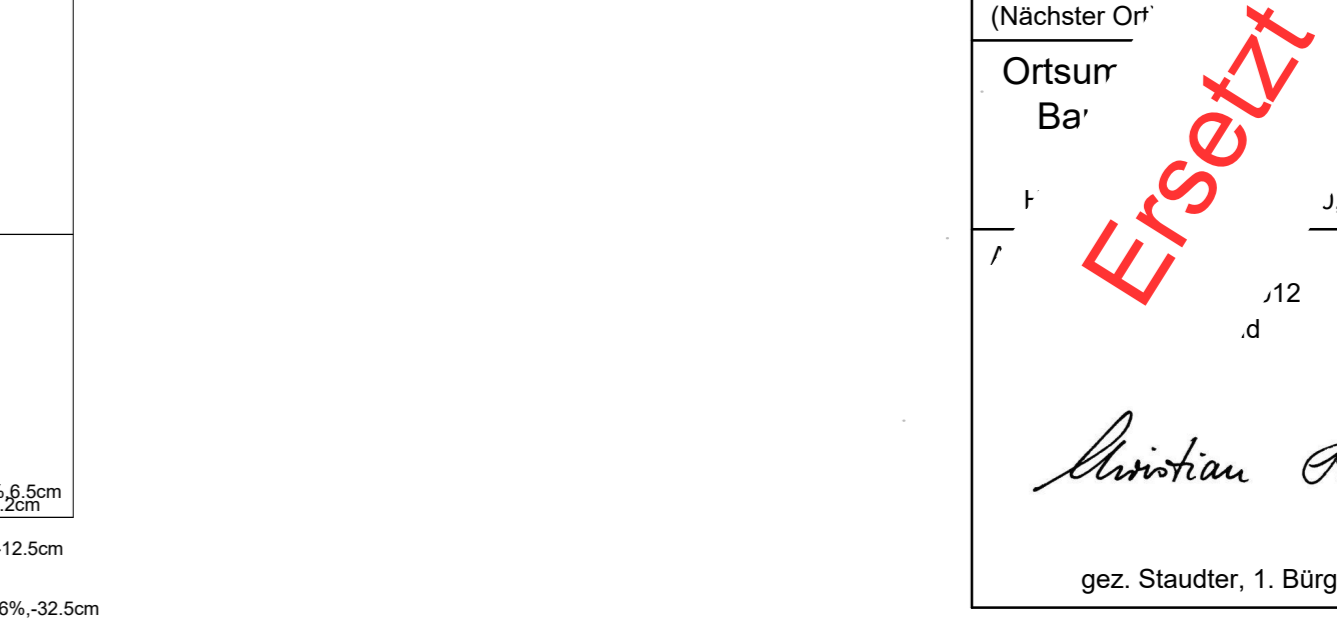

Rampe 1

Station	m
374.284	374.284
374.432	374.432
379.928	379.928
380.573	380.573
380.71	380.71

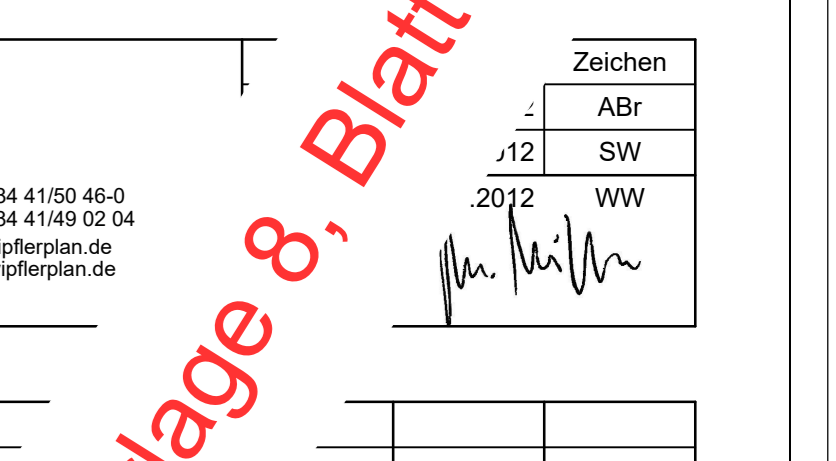

Rampe 2

Station	m
368.53	368.53
367.81	367.81
370.13	370.13
367.43	367.43



Kreisfahrbahn

Station	m
393.535	393.535
393.198	393.198
393.344	393.344
393.300	393.300
393.535	393.535

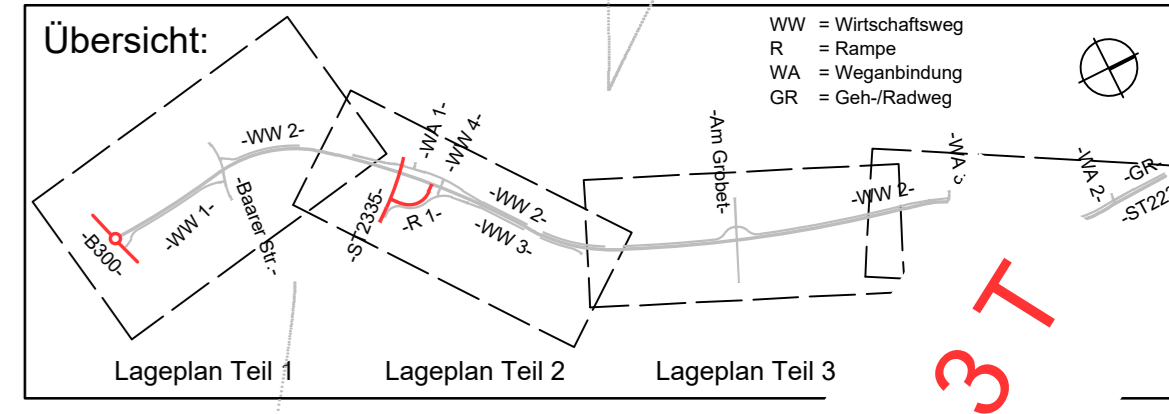

Entwurfsbearbeitung:
Wipfler PLAN
 Wipfler PLAN
 Planungsgesellschaft mbH
 Höhenwarter Str. 124
 85276 Pfaffenhofen/Ilm
 Tel.: 0 84 41/50 46-0
 Fax: 0 84 41/49 02 04
 www.wipflerplan.de
 info@wipflerplan.de

Nr.	Datum	Name

Auftraggeber: J. Geisenfeld

Straße: .32

Ortsur: Nord-West

Ba: au-km 4+186

Ort: im - Vohburg

Objekt: J, ST 2335, Rampe 1+2

Maßstab: 1:2000/200

Unterlage 8
 Blatt Nr. 3
 Reg. Nr. .

Höhenplan
 gezeichnet
 geprüft

Christian Staudter
 gez. Staudter, 1. Bürgermeister

Ersetzt durch Unterlage 8, Blatt 3 T